

# PRORIL

50 Hz

Serving a wide range of slurry transport applications, STORMY-P series pumps are designed for long wear life, low energy consumption, excellent performance, and easy maintenance. With patented ACrS Tech and rugged construction, these abrasion and corrosion resistant slurry pumps provide economical solutions for challenging slurry transportation.

**Slurry and Sand Pump**

## **STORMY 6150P**

Open Stand and Agitator Pump



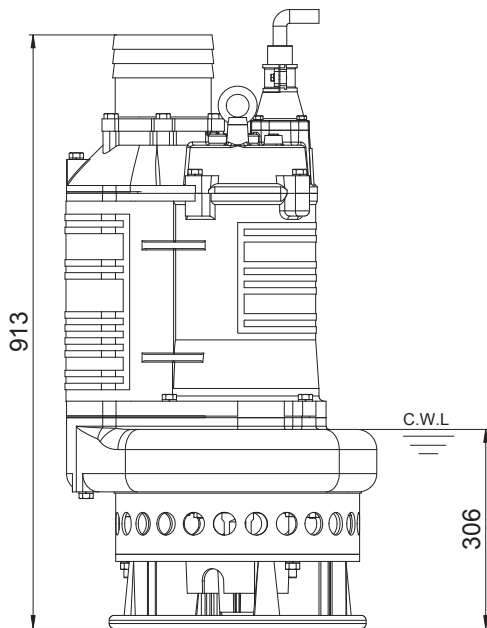
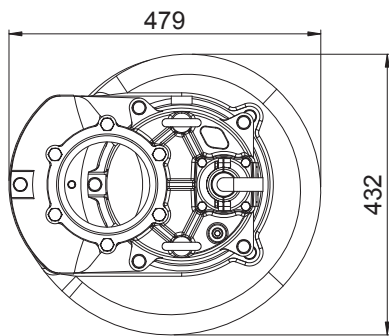

Weight : 201kg / 443lbs

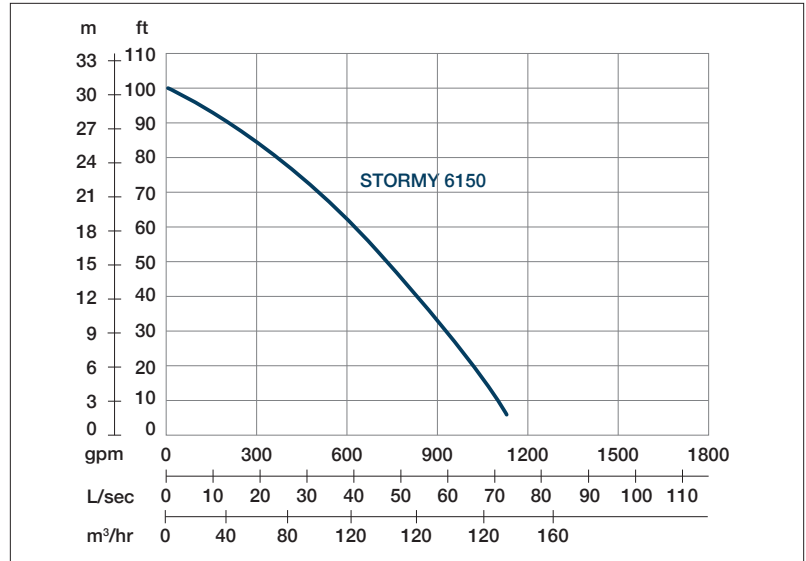

Shaft Speed : 1450 rpm

Outlet : 150mm, 6in

OUTPUT	HEAD	FLOW
15 kW	Rated : 20m, 66ft	Rated : 35 l/s, 555 gpm
20 HP	Max : 31m, 100ft	Max : 72 l/s, 1136 gpm

Pump Type		Electric Submersible Pumps
		3-Phase
Motor	Type	Induction Motor
	Poles	4 Pole
	Insulation	Class F
	Protector	Circle Thermal Protector
	Starter	D.O.L.
Lubricant		Food Grade (ISO VG32)
Impeller Type		Opened
Shaft Seal		Double Mechanical Seal
		Silicon Carbide VS Ceramic / Carbon
Bearings		C3 Shielded ball bearings
Cable		H07BQF
		Length: 20m (66ft) or longer upon request.
Materials	Pump Casing	Ductile Iron
	Impeller	Chromium Iron
	Motor Frame	Gray Iron
	Motor Shaft	Stainless Steel
	Wear Plate	Chromium Iron
	Agitator	Chromium Iron
Max. Liquid Temperature		104°F (40°C)
Max. Submersion Depth		66ft (20m)
pH Range		pH 5 - pH 8