

PRORIL

50 Hz

Serving a wide range of slurry transport applications, STORMY-S series pumps are designed for long wear life, low energy consumption, excellent performance, and easy maintenance. With patented ACrS Tech and rugged construction, these abrasion and corrosion resistant slurry pumps provide economical solutions for challenging slurry transportation.

Slurry and Sand Pump

STORMY 337S

Strainer and Agitator Pump



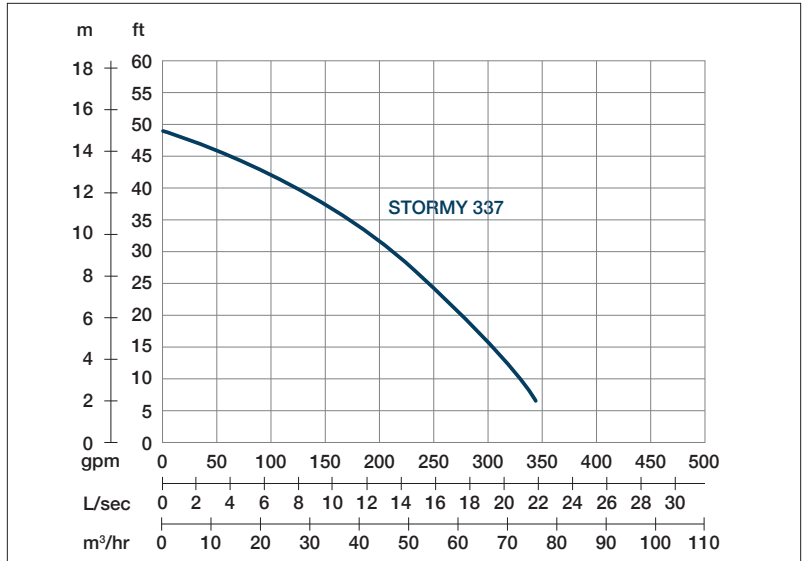
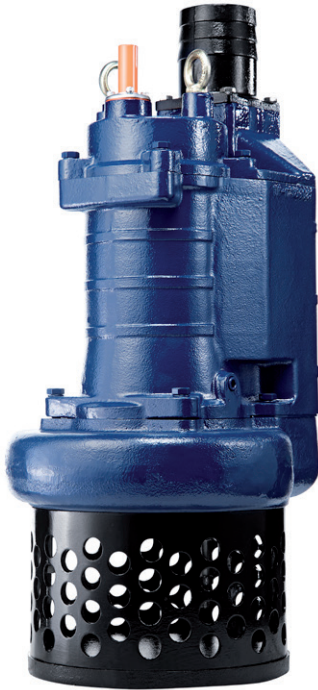

Shaft Speed : 1450 rpm

Outlet : 80mm, 3in

OUTPUT	HEAD	FLOW
3.7 kW	Rated : 10m, 33ft	Rated : 12 l/s, 185 gpm
5 HP	Max : 15m, 49ft	Max : 22 l/s, 343 gpm

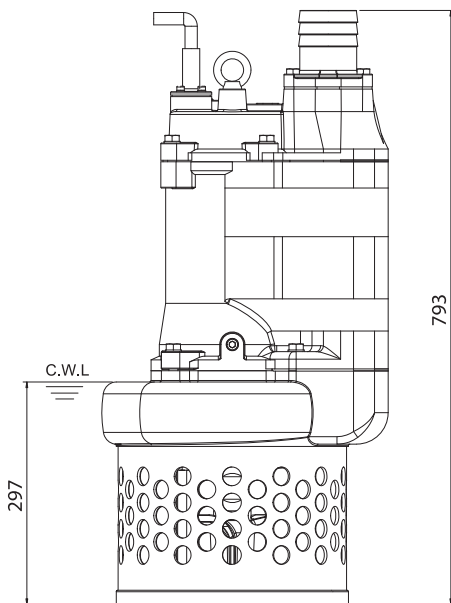
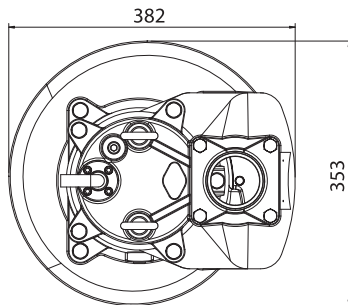

Weight : 115kg / 254 lbs

Pump Type	Electric Submersible Pumps	
	3-Phase	
Motor	Type	Induction Motor
	Poles	4 Pole
	Insulation	Class F
	Protector	Circle Thermal Protector
	Starter	D.O.L.
Lubricant	Food Grade (ISO VG32)	
Impeller Type	Opened	
Shaft Seal	Double Mechanical Seal	
	Silicon Carbide VS Ceramic / Carbon	
Bearings	C3 Shielded ball bearings	
Cable	H07BQF	
	Length: 20m (66ft) or longer upon request.	
Materials	Pump Casing	Ductile Iron
	Impeller	Chromium Iron
	Motor Frame	Gray Iron
	Motor Shaft	Stainless Steel
	Wear Plate	Chromium Iron
	Agitator	Chromium Iron
	Strainer	Carbon Steel
Max. Liquid Temperature	104°F (40°C)	
Max. Submersion Depth	66ft (20m)	
pH Range	pH 5 - pH 8	